

WAYEL Electricbikes

> W3



FIVE SRL

Via Cerodolo 4 | 40138 Bologna | Italy

T +39 051 0316272 | www.wayel.it | info@wayel.it

Welcome to the family of LX06max owners! We will guide you to know each function for the right and safe use of electric scooters.

To ensure your safety, please read this manual carefully before riding and make sure you are always following the requirements below:

- Fully understand the information in this manual, including but not limited to the relevant instructions, precautions and warnings.
- Fully understand the operation and contingency measures of electric scooters.
- Be fully aware of warning labels of LX06max electric scooters.
- We will not take any responsibility resulting from the unauthorized modification, failure to use original spare parts, or installation of components that affect the performance and safety of the scooter.

*Please contact the Local Customer Service Center if you have any questions about this scooter.
We are at our service at any time. Wish you safe and pleasant riding experience!*

Checks Before Riding

Make sure to check the following items before riding a electric scooter, which will guarantee your safety on the road.

- ① Whether the handlebar is stable and flexible when turning.
- ② Whether the switches on the right and left handlebars can work normally.
- ③ Whether the speed accelerator can work normally.
Make sure the tire pressure is normal. The suggested tire pressure is 26-29psi for front wheel and 29-32 psi for rear wheel.
- ④ Check tire surface for cracks, damage, wear, and foreign matter puncture or attachment
- ⑤ Whether the tread depth is sufficient (>0.8 mm).
- ⑥ Whether any fault warning light on the instrument panel goes on after being powered.
- ⑦ Whether the battery is fully charged.
- ⑧ Whether the head and tail lights, brake lights and wipers can work normally.
- ⑨ Whether the horn can work normally.
- ⑩ Whether the rear mirrors are clean. Adjust them to the appropriate angle.
- ⑪ Whether the brake oil is sufficient, and whether the handlebars and brake system can work normally.
- ⑫ For any abnormality or operational concern, please contact local Customer Service Center.

To ensure the safety of you and others, please make sure to observe the following matters:

- Do not ride after you take medications, drink alcohol, or when you are unwell, which may affect your riding ability.
- Observe traffic regulations and traffic signs and confirm the surrounding road conditions and scooter conditions at any time to avoid danger.
- Wear safety equipment, such as helmet, and appropriate protective clothing if necessary, such as gloves and boots.
- Perform a basic check each time before riding, so as to confirm the light, brake, tread and tire pressure and check other parts for looseness or abnormal noise, and regularly go to Local Service Center for maintenance.
- In order to ensure the safety of you and others, please DO NOT use high beam in good lighting conditions. The continuous use of high beam will cause the visual disturbance to vehicles and pedestrians on the opposite side, thus affecting normal driving.
- Please do not make or answer any call during riding, which is likely to cause traffic accidents.

Installation of Mirrors

1

Take out the left and right mirrors, insert the hole and rotate the mirror clockwise to the correct position.

2

Use the spanner to fasten the nut, make sure the left and right mirror is on the same line and suitable for the driver's view.

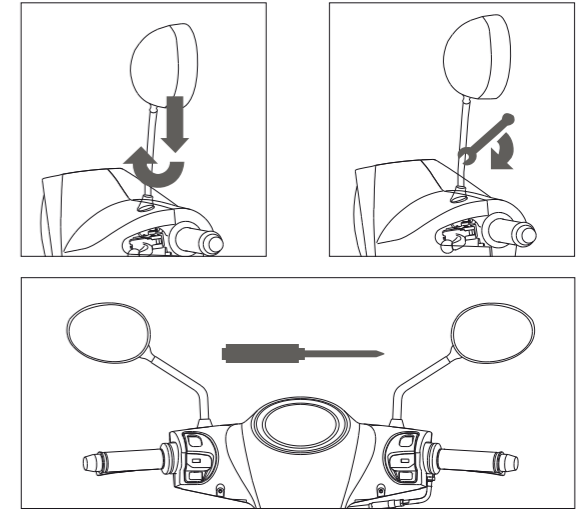

DESCRIPTION OF COMPONENTS AND PARTS

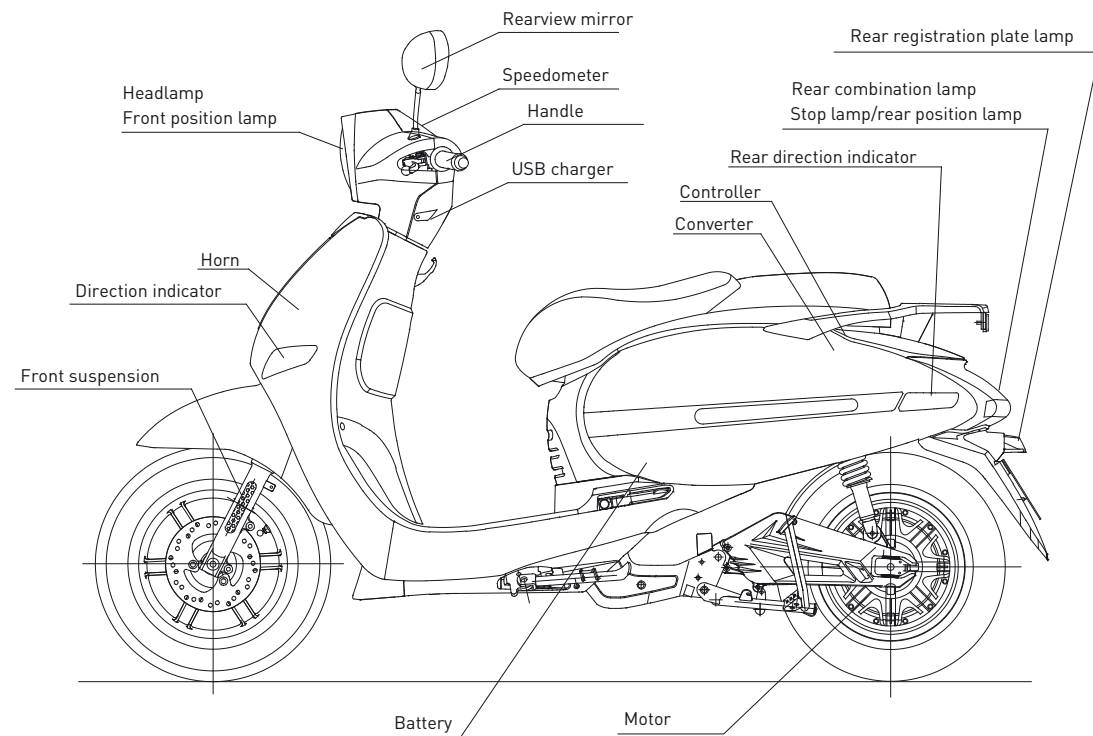
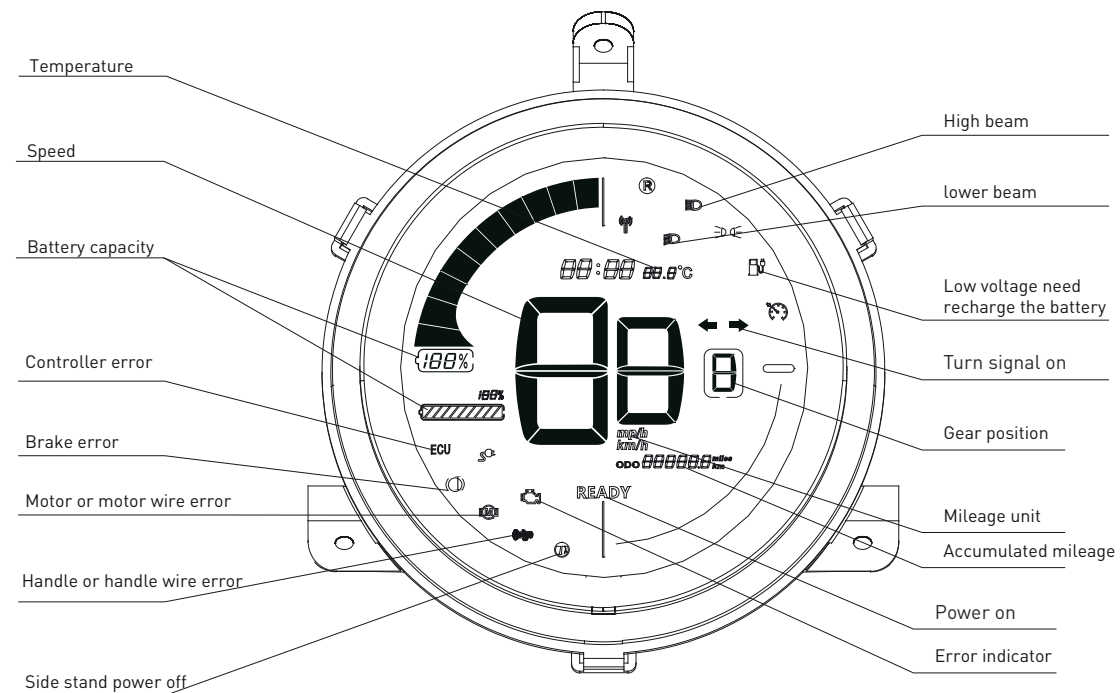

DIAGRAM OF INSTRUMENT PANEL



Details Of Instrument Panel

Lamp	Function
READY	Power on
↔	Turn signal on
BB.θ°C	Meter working temperature
⊕	Low voltage for the battery to the limit level
Ⓟ	Side stand power off
ECU	Controller error
Ⓜ	Motor or motor wire error
⚠	Brake or brake wire error
Ⓜ	Handle or handle wire error
Ⓟ	Scooter in P position

Lamp	Function
⊕	Low voltage need recharge the battery
Ⓜ	High beam on
Ⓜ	Motor error, erase the error and run the motor for 4 minutes, the error indicator will disappear automatically.
000000.0	First showing the accumulated milage and then single milage with 0000.0. Speed unit (mile/km) synchronous switches.
ODO 000000.0	Total milage of the scooter. Speed unit (mile/km) synchronous switches. (ODO is accumulated milage).
Ⓜ	Gear postion display; single driving time
Ⓜ	Speed display, km/h & mp/h switch is available; external plug switch (off is km/h, on is mp/h)
100%	Battery capacity level

Left Start Button

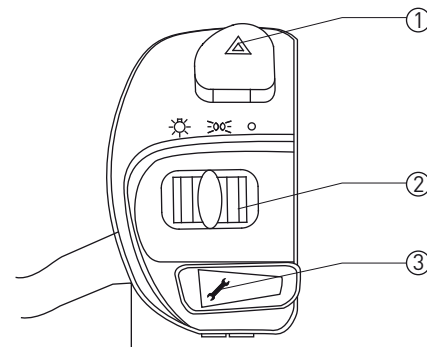

Item	Switch position	Functions
①	Emergency glasher	Push upward the switch, all turning lights on and flick, same display on the meter
②	Switch of headlight	Push to left and right to switch on/off the head lamp.
③	Repair button	Press the " Repair" button to drive the scooter in low speed when some motor/controller errors happens.

Right Start Button

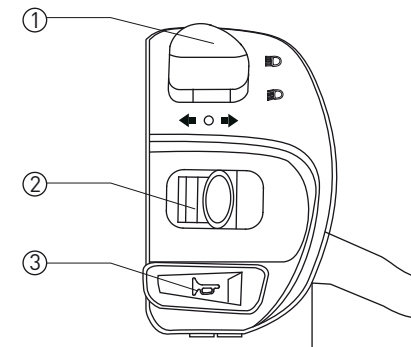

Item	Switch position	Functions
①	Near-far light switch	Ⓜ High beam is on when turning on the button
		Ⓜ Low beam is on when turning on the button
②	Indicator control	← Left turning signal on
		→ Right turning signal on
③	Horn control	Ⓜ Horn on

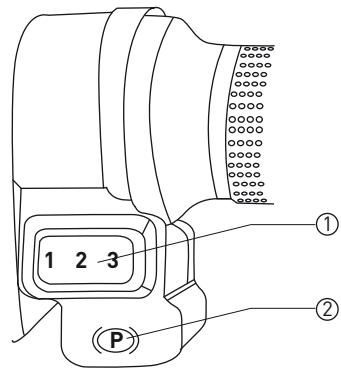

Item	Switch position	Functions
①	Speed levels	Press the button to adjust the speed level, level information will be synchronous shown in meter
②	P gear position	Press the ignition key for 1 second to release the P gear until the "P" mark in the meter disappear; The speed regulating function is still effective when the P gear function is normally turned on; when the power is on and the whole vehicle stops, press the P button for 1 second to enter the P gear position, the P mark is synchronous in the meter.

TIPS:

Before riding, make sure the electronic side stand retracted and rotate the handlebar to ensure that the handlebar lock is closed. If the Parking button is pressed when riding, the bike will be dis-energized. So DO NOT press it when riding for avoiding danger caused by the sudden loss of power.

If the electronic side stand is extended when riding, the bike will be dis-energized. So DO NOT extend the electronic side stand when riding for avoiding danger caused by the sudden loss of power.

The scooter must be fully stopped before starting. In case of abnormality during riding, please ride carefully or push it to a safe place. DO NOT try restarting the bike during riding or on the lane so as to avoid danger

Guide of ignition key

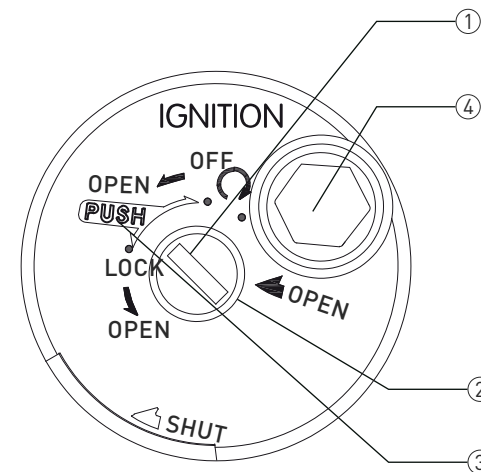

① Start power supply

Turn the key to position and power on the scooter.

ATTENTION:

1. Make sure all lights are in "off" condition, or it may cause power-off protection due to battery protection program ;
2. If the power-off protection happen, switch off the lights and restart the circuit breaker and power on the scooter again.

② Open the saddle

Turn the key to left to open the saddle.

③ Handle bar lock and relieve

1. Turn the handle bar to left until stop;
2. Push the key and turn to left till () position, the handle bar is locked;
3. Push the key and turn to right till () position, the handle bar is unlocked.

④ The key hole status

1. The key hole is closed when in () position;
2. Turn the key towards to () position, the key hole is in open position.



Install the cable

- ① Open the small cap on the top of battery case
- ② Align the power cord with the white arrow on the socket. Insert slowly and press firmly until you hear a "clicking" sound.



Remove the power cord

- ① The power plug can be pulled out by rotating the blue buckle ring counterclockwise and pulling it up with force.
- ② Make sure the two sets of battery capacity difference less than 20%, or it will cause the scooter enter into lower speed condition; Single battery will cause the lower speed condition as well.

How To Operate The Smart Remote Control

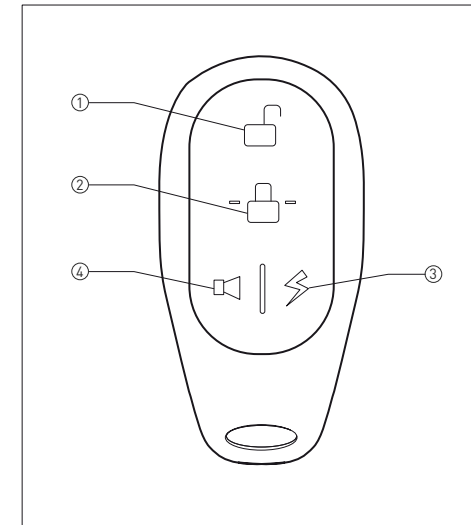

With the advanced Smart Remote Controller, you can easily lock or unlock your electric scooter by simply pressing the button within 50 meters.

- ① **Unlock**
Press the unlock button, and the start button stays on. The scooter enters into the unlocked state.
- ② **Lock**
When the scooter is in the static state, press the lock button, and the start button flashes. The scooter enters the locked state.
- ③ **Remote keyless entry**
After unlock the scooter, press this button twice within two[2] seconds, and the scooter will be in the "Powered" state without key.
- ④ **Search key**
Press this witch within 50m, "Bi Bi" sounds searching the scooter.

Guide of the USB



1. Open the dust cover of the USB charging port;
2. Connect the cable

Guide for side stand power off fuction



Handlebar is short of power, scooter not able to be started



Scooter ON position, scooter can be powered on.

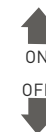

ON

When the master switch is ON, the vehicle's main power source is connected.

OFF

When the master switch is OFF, the vehicle's main power source is disconnected.

How to Charge the Battery

- ① Insert the main charger plug into the charging port of the scooter.

Insert the charger's AC power plug into the home power socket, and the battery starts charging when the charger indicator turns red. The battery is fully charged if the charger indicator turns from red to green.

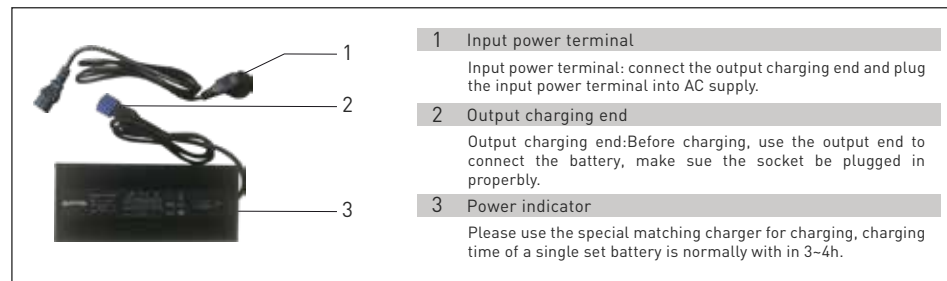
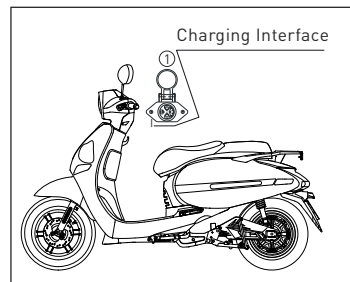

- ② Pull up the battery from scooter, insert the main charger plug into the charging socket of the battery. Insert the charger's AC power plug into the home power socket, and the battery starts charging when the charger indicator turns red. The battery is fully charged if the charger indicator turns from red to green.

TIPS:

Short circuit of the cathode and the anode at the battery's input.

Keep it away from children, fire and heat source. It is strictly forbidden to throw it into the fire; Violent movements, shock and extrusion are prohibited;

Only the specified charger can be used, and other chargers are prohibited to charge the battery;

This product has been subjected to strict inspection before leaving factory, and it is strictly prohibited to dismantle it. Please contact our company's after-sales department for any question.

TIPS:

Do not expose the battery to water, and prevent it from being damped by water or rained.

Charge temperature: 0-45 °C, discharge temperature: -20-45 °C;

Battery capacity will be reduced when placed in a low-temperature environment;

Charge the battery when you use it, but make sure to charge it before the capacity is lower than 20%. When it is not used

for a long time, please remove it from the scooter.

Storage, Maintenance and Transportation

Please charge the battery to half-saturation state when storing or transporting it (after the battery is discharged, charge it for 3 hours).

Place it in a dry and ventilated place;

Battery and charger should be kept in a clean, dry, and ventilated place. Keep them away from corrosive materials, power source and heat source;

Storage conditions: ambient temperature -20-35 °C, humidity < 65% RH;

When storing the charger, please disconnect it from the battery.

Regular maintenance can enhance the service life and driving safety of the electric scooter. Please refer to the following suggestions and take care of your scooter.

Routine Cleaning and Maintenance

Cleaning: Please use clean water and neutral detergent to clean it, and use soft cloths and sponges to clean the surface;

It is prohibited to use metal brushes, sandpaper or the like to clean it, in order not to scratch the parts surface. After cleaning, dry it with soft cloths.

TIPS:

Please disconnect the air switch before cleaning.

Do not use strong water jet to directly wash it, so as to avoid the default of mechanical parts caused by water invasion.

Storage: try to park it in a dry and cool room to reduce the exposure to sun and rain and avoid the reduction of service life due to corrosion of parts.

When left unused for a long time, please turn off the air switch and disconnect the power supply circuit to prevent over discharging.

After long-term storage, please fully charge it before use.

Regular Inspection and Maintenance

The new scooter must be subject to the first inspection and maintenance in the Service Center when it reaches 1,000 km or two months (whichever comes first).

The scooter is recommended to be subject to regular inspection and maintenance in the Service Center at every 3,000 km or six months (whichever comes first).

TIPS:

Please disconnect the air switch before cleaning.

Do not use strong water jet to directly wash it, so as to avoid the fault of mechanical parts caused by being damped.

Regular maintenance can improve the service life and driving safety of the electric scooters.
Please refer to the following suggestions and take care of your scooter.

Failure	Causes	Solutions
The scooter has no electricity, and the READY lamp does not shine.	Battery is poorly connected. Air switch is not turned on.	Connect the battery properly at its main plug. Turn on the air switch.
When turning the speed regulating steering handle-bar, the motor does not turn after being powered.	Low battery volume. Side stand is not retracted. Brake handle does not reach the right position. Steering handlebar failure. The controller plug is loose. Controller failure.	Charge the battery. Put away the side stand. Close the parking key. Place the brake handle at the right position. Change handlebar. Re-plug controller. Change controller.
Speed is slow or mileage is short.	Low battery. Under-inflated tire. Heavily overloaded. Brake pads interference. Battery aging or normal scrap.	Charge the battery. Inflate the tire, and check the tire pressure before riding. Foster a good habit, and keep the appropriate load Change the brake pads and check the brake system before riding. Change battery. Check whether the main plug is in a right place Use the special charger.
Battery can not be charged.	Poor contact of the main plug of the charger. Do not use the wrong charger. Battery aging or normal scrap. Battery low-voltage protection.	Contact of the main plug again. Contact with local service office of battery.

